

Vue sur connecteur  
Detail on connector

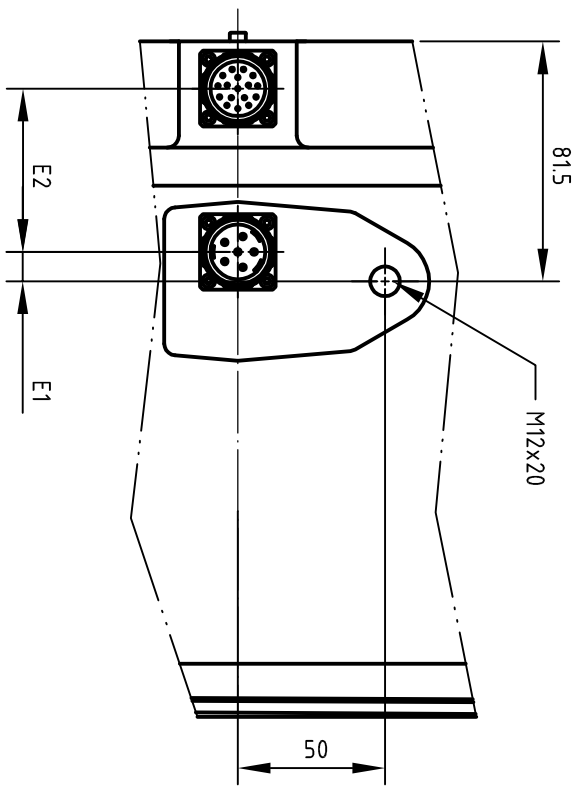
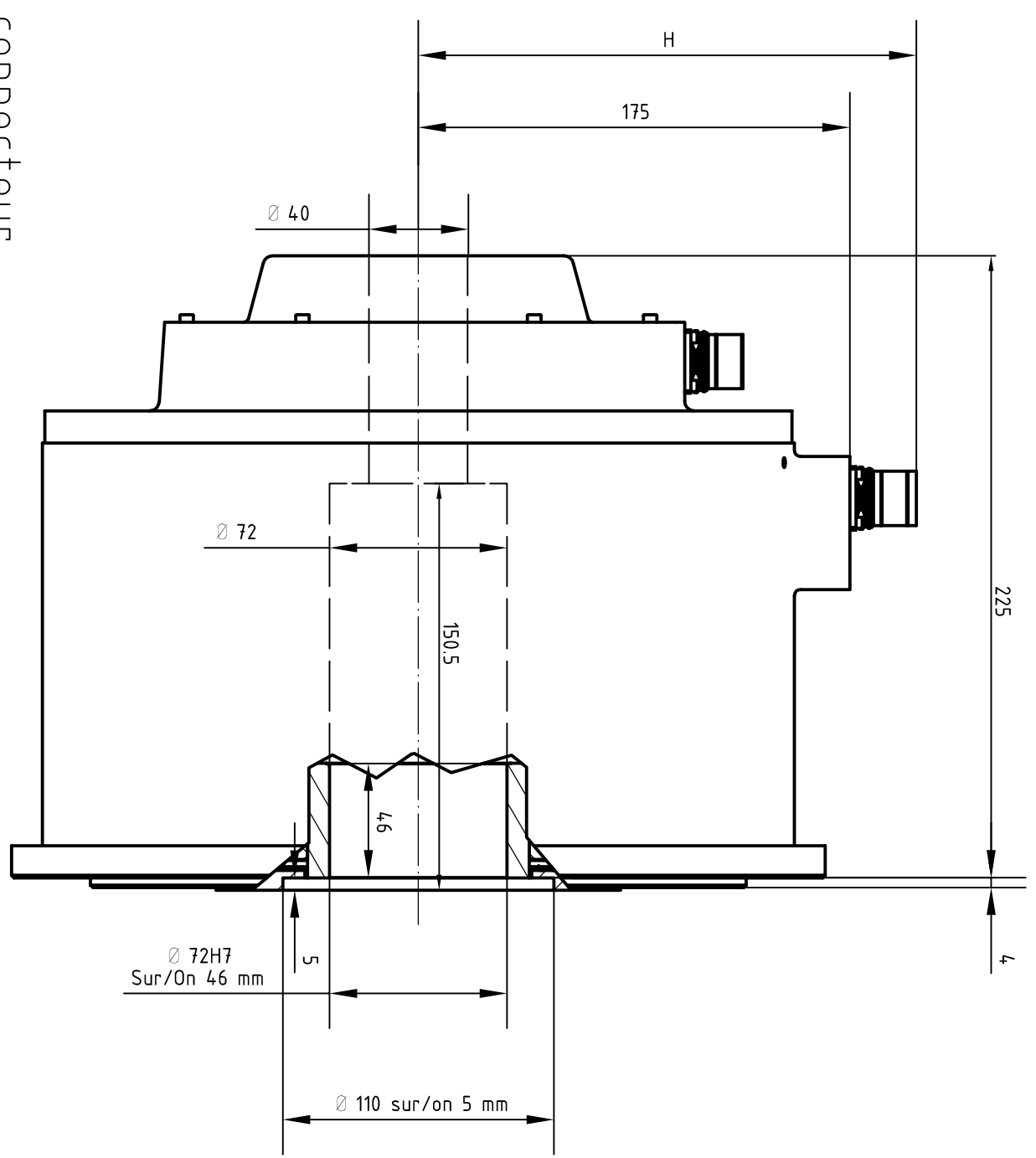

Courant à couple permanent Current at continuous torque	H	E1	E2
< 25 A	202	10	55.5
> 25 A	217	2	63.5

**ALXION**

AUTOMATIQUE & PRODUCTION  
Parc Technologique des Fosses Jean  
92712 COLOMBEES Cedex  
Tél: 014.1306304 - Fax: 014.1306136

300ST2M18[2-7]XXXXCX